

Ending nuts

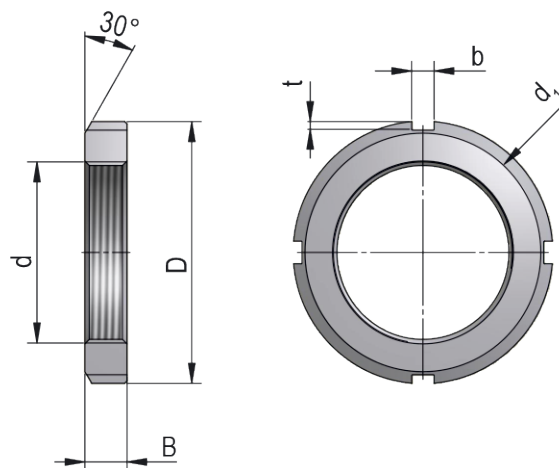

Sleeve Designation **KM6**

Appropriate Components

Locking Washer **MB6**

Dimensions (mm)

d	M30x1,5
d ₁	38
D	45
B	7
b	5
t	2
	-

Weight [kg] 0,038