

Ending nuts

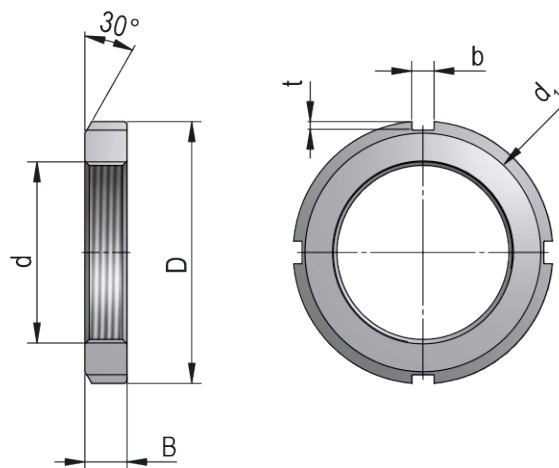

Sleeve Designation

KM18

Appropriate Components

Locking Washer

MB18

Dimensions (mm)

d	M90x2
d ₁	108
D	120
B	16
b	10
t	4
	-

Weight [kg]

0,51