

Ending nuts

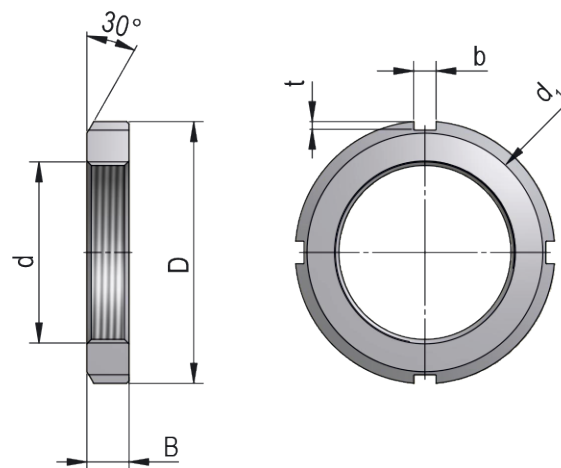

Sleeve Designation

KM14

Appropriate Components

Locking Washer

MB14

Dimensions (mm)

d	M70x2
d ₁	85
D	92
B	12
b	8
t	3,5
	-

Weight [kg]

0,22