

Ending nuts

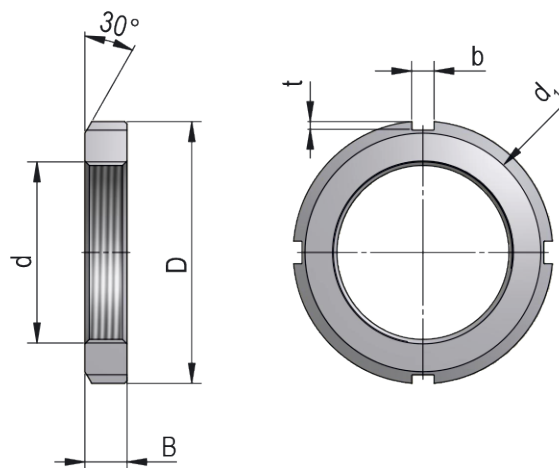

Sleeve Designation

KM13

Appropriate Components

Locking Washer

MB13

Dimensions (mm)

d	M65x2
d ₁	79
D	85
B	12
b	7
t	3
	-

Weight [kg]

0,19