

Ending nuts

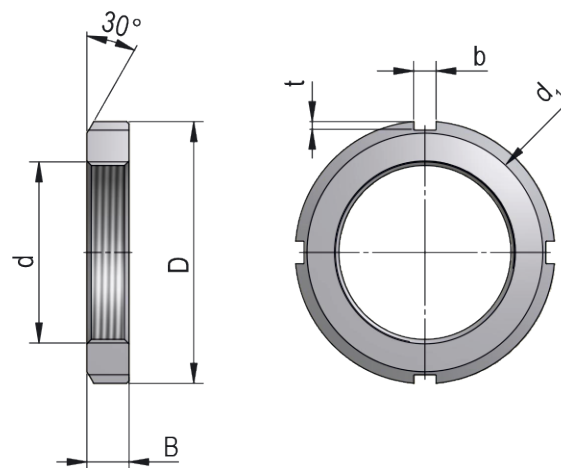

Sleeve Designation

KM12

Appropriate Components

Locking Washer

MB12

Dimensions (mm)

d	M60x2
d ₁	73
D	80
B	11
b	7
t	3
	-

Weight [kg]

0,16