

Adapter sleeves

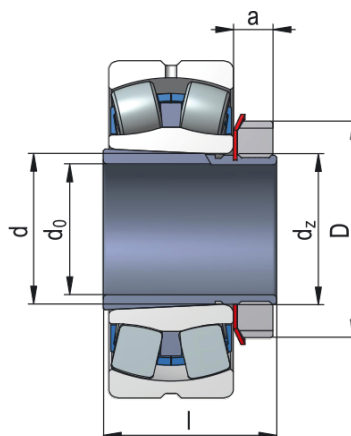

Sleeve Designation	H2304
---------------------------	--------------

Appropriate Components	
Nut	KM4
Washer	MB4

Dimensions (mm)

d_0	17
d	20
D	32
l	31
a	7
a_1	-
d_z	M20x1
d_{z1}	-

Weight [kg]	0.05
--------------------	------