

Adapter sleeves

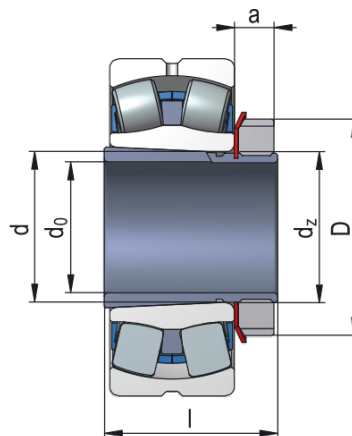

Sleeve Designation	H304
---------------------------	-------------

Appropriate Components	
Nut	KM4
Washer	MB4

Dimensions (mm)

d_0	17
d	20
D	32
l	28
a	7
a_1	-
d_z	M20x1
d_{z1}	-

Weight [kg]	0.04
--------------------	------