

# Adapter sleeves

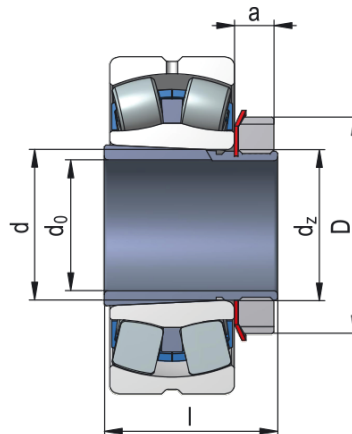

<b>Sleeve Designation</b>	<b>H307</b>
---------------------------	-------------

<b>Appropriate Components</b>	
<b>Nut</b>	<b>KM7</b>
<b>Washer</b>	<b>MB7</b>

## Dimensions (mm)

$d_0$	30
$d$	35
$D$	52
$l$	35
$a$	9
$a_1$	-
$d_z$	M35x1.5
$d_{z1}$	-

<b>Weight [kg]</b>	0.14
--------------------	------