

Oval Flanged Cast Housing Unit - FM type

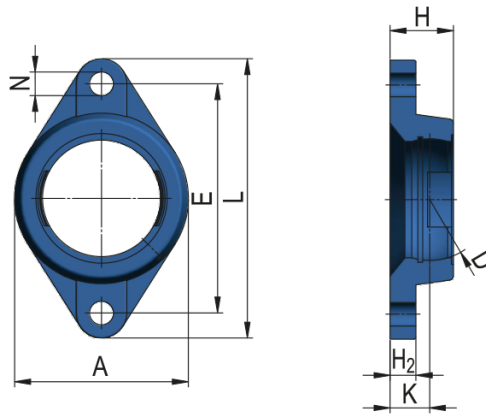

Housing Unit Designation

FM208; FMC208

Dimensions (mm)

A	100
D	80
E	144
L	175
H	36
K	21
H ₂	14
N	16

Weight [kg]

0,82