

# Oval Flanged Cast Housing Unit - FM type

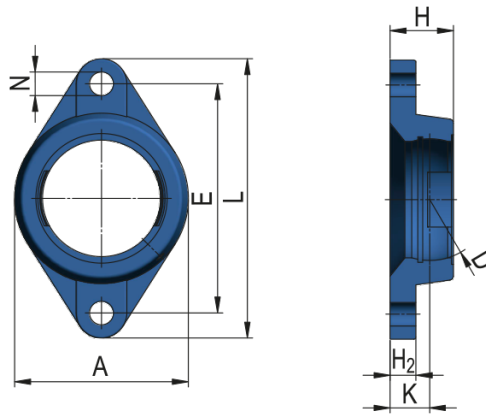

Housing Unit Designation

**FM206; FMC206**

## Dimensions (mm)

A	80
D	62
E	117
L	148
H	31
K	18
H <sub>2</sub>	13
N	16

Weight [kg]

0,510