

Oval Flanged Cast Housing Unit - FM type

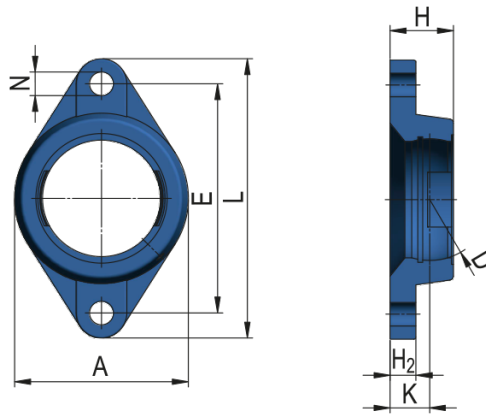

Housing Unit Designation

FM216; FMC216

Dimensions (mm)

A	180
D	140
E	233
L	290
H	58
K	34
H ₂	22
N	25

Weight [kg]

4,18