

Oval Flanged Cast Housing Unit - FM type

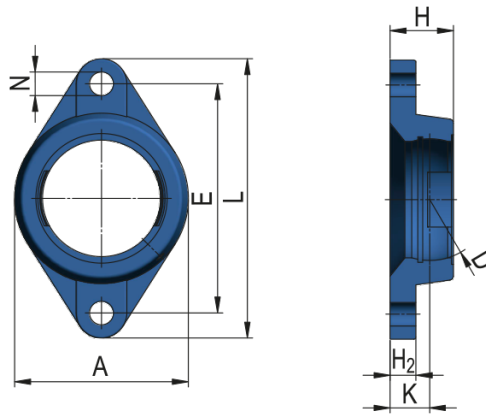

Housing Unit Designation

FM215; FMC215

Dimensions (mm)

A	165
D	130
E	225
L	275
H	56
K	34
H ₂	22
N	23

Weight [kg]

3,43