

Pillow Block Housing Unit - SG type

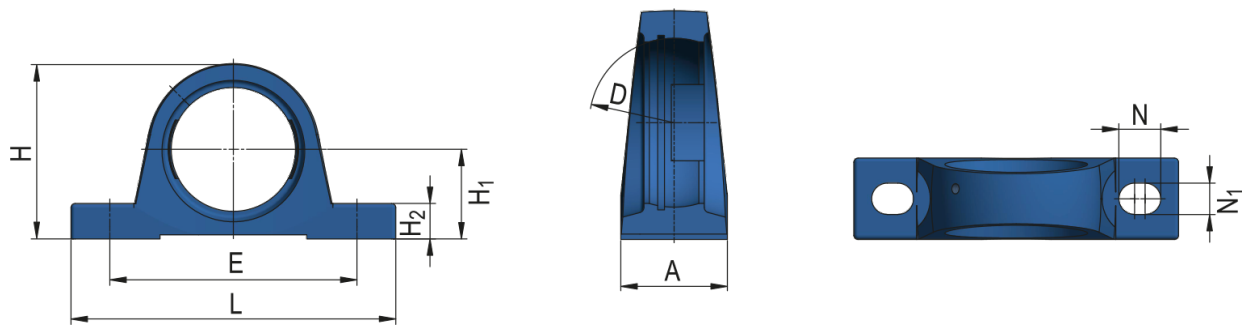

Housing Unit Designation

SG208; SGC208

Dimensions (mm)

A	52
D	80
E	136
L	178
H	97
H ₁	49,2
H ₂	18
N	21
N ₁	17

Weight [kg]

1,11