

Pillow Block Housing Unit - SG type

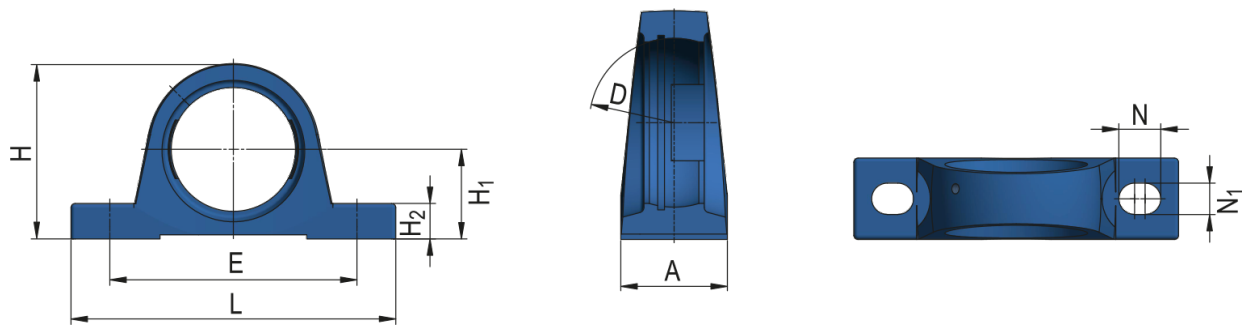

Housing Unit Designation

SG206; SGC206

Dimensions (mm)

A	46
D	62
E	121
L	163
H	82
H ₁	42,9
H ₂	17
N	21
N ₁	17

Weight [kg]

0,850